

MERCEDES BENZ OTROS MODELOS

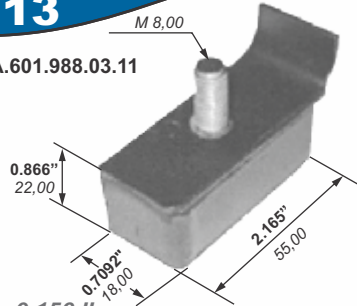

1313

PL: A.601.988.03.11



71 gr. 0.156 lb.

TOPE DE GOMA
RUBBER BUTT

1315

PL: A.901.743.04.29

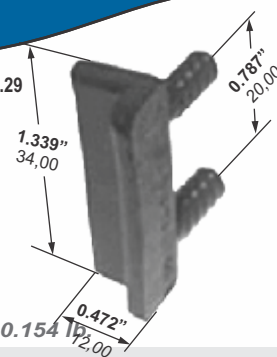

70 gr. 0.154 lb.

TOPE DE GOMA
RUBBER BUTT

1316

100 gr. 0.220 lb. PL: A.901.476.00.26



MANGUERA TUBO LLENADO
TUBE FILLING HOSE

1318

PL: A.901.476.00.26

20 gr. 0.044 lb.



PASACABLE
CABLE HOLDER

1335

PL: A.384.291.70.41

17 gr. 0.037 lb.

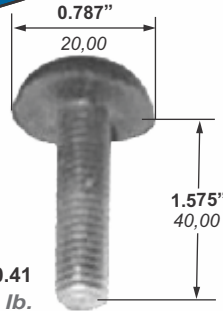

TOPE
BUTT

1336

100 gr. 0.220 lb. PL: A.667.317.00.36



TOPE DE GOMA
RUBBER BUTT

1337

6 gr. 0.013 lb. PL: A.110.987.07.44

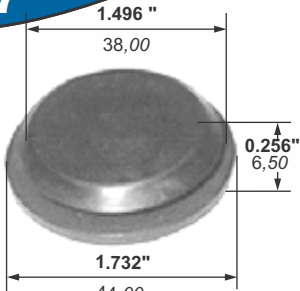

ARANDELA DE CIERRE
RING SEAL

1338

PL: A.692.988.70.11

16 gr. 0.035 lb.

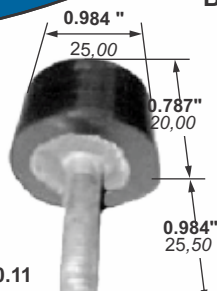

TOPE DE GOMA
RUBBER BUFFER

BUS

1339

PL: A.667.323.06.85

58 gr. 0.441 lb.



BUJE DE GOMA
RUBBER BUSHING

1317

520 gr. 1.146 lb. PL: A.390.350.70.75



TOPE DE GOMA
RUBBER BUTT

1373

54 gr. 0.128 lb. PL: A.318.322.02.50

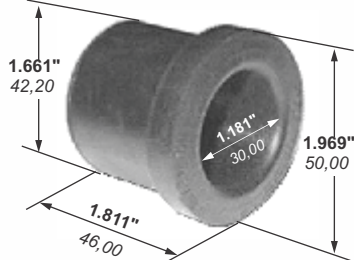

BUJE DE GOMA
RUBBER BUSHING

1430

PL: A.390.350.74.75 FERVI AIR:04-0410

8 gr. 0.018 lb.

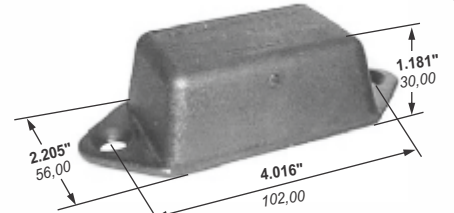

SOPORTE
SUPPORT

CAPEMI®

Líderes en goma
y goma metal



MERCEDES BENZ OTROS MODELOS



1900

MB710

mm.	Inch.
d: 36,5	1.437
D: 56,5	2.224
L: 34,5	1.358
l: 43,5	1.713



PESO: 327 Gr.
WEIGHT: 0.721 Lb.

BUJE DE ELASTICO TRASERO (PARTE DELANTERA)
REAR SPRING BUSHING (FRONT SIDE)

1901

MB710

mm.	Inch.
d: 30,1	1.185
D: 50,1	1.972
L: 34,5	1.358
l: 30,5	1.201



PESO: 330 Gr.
WEIGHT: 0.728 Lb.

BUJE DE ELASTICO TRASERO (PARTE DELANTERA)
REAR SPRING BUSHING (FRONT SIDE)

7333

MB526

mm.	Inchs
h: 66	d: 2.598
l: 160	D: 6.299
L: 100	l: 3.937

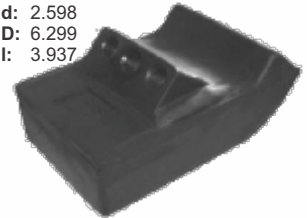

PL: 321.220.02.17

SOPORTE DELANTERO Y TRASERO DE MOTOR
FRONT & REAR ENGINE MOUNT

